

<S3R0G3R0GA Dimension of External>

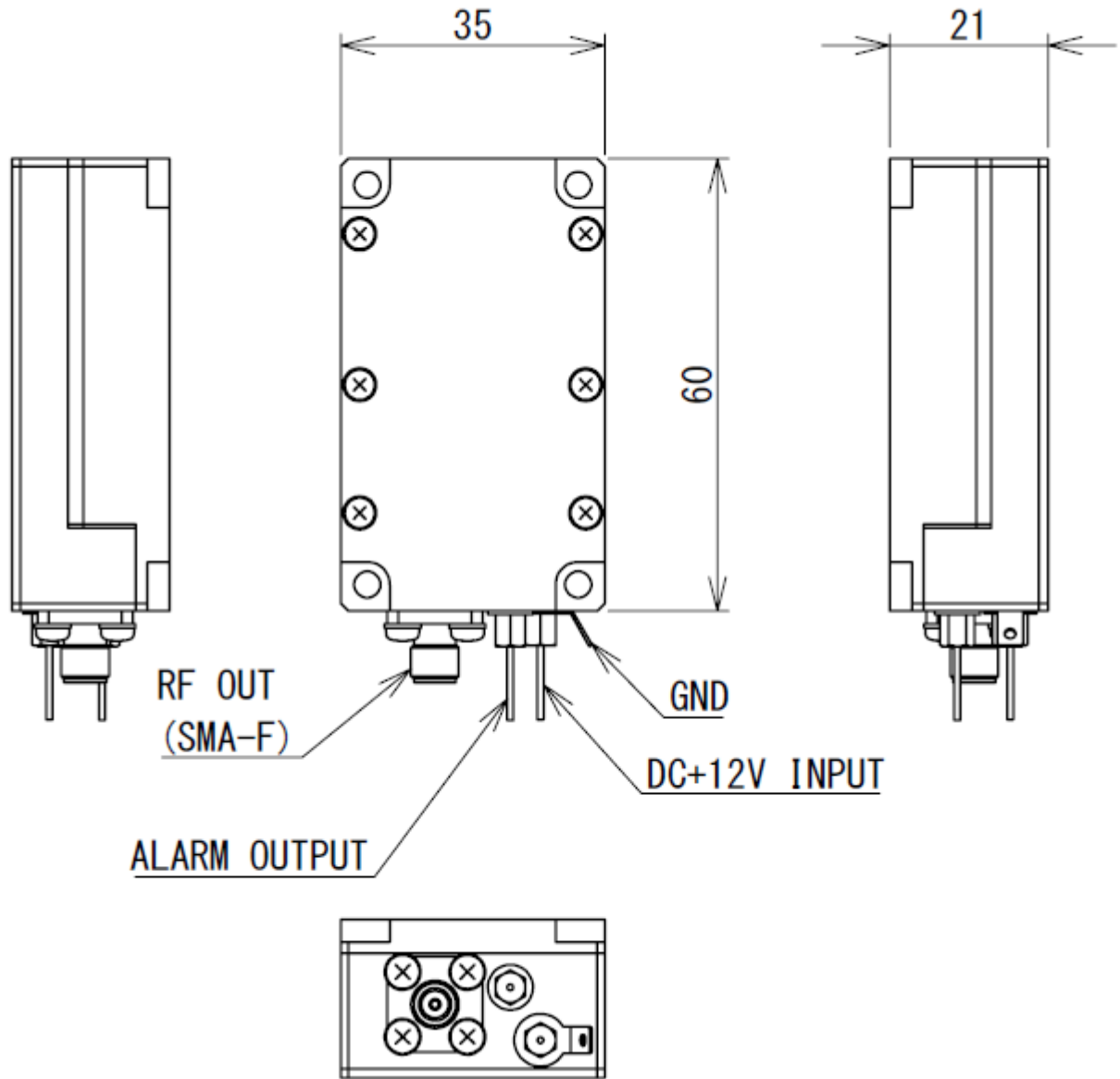

UNIT : [mm]