

Temperature compensated crystal oscillator

■ NT2016SJA Data Sheet

TCXO (Low phase noise / With Stand-by function. / ± 0.5 ppm)

Applications

- Smartphone/mobile phone
- Wireless module
- GPS/GNSS modules, etc.

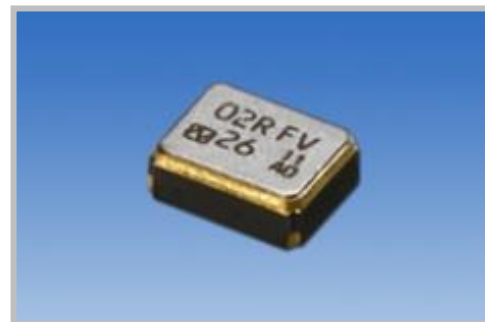

RoHS Compliant
Directive 2011/65/EU
Directive (EU) 2015/863

**Pb
free**

**Halogen
free**

Features

- Low noise characteristics optimized for GPS applications.
- Highly stable frequency temperature characteristics.
- With Stand-by function.
- Supports low power supply voltage.
(Supports DC +1.7 V to +3.3 V. Standard specification: +1.8 V)
- Ultra-compact and light with a height, cubic volume, and weight of Max. 0.8 mm, 0.0022 cm³, and 0.008 g, respectively.
- Low power consumption.
- A surface-mount crystal oscillator. (Reflow soldering is possible.)
- Lead-free. Meets the requirements for re-flow profiling using lead-free solder.

1. Item : Temperature compensated crystal oscillator (TCXO)
 2. Type : NT2016SJA
 3. Nominal frequency : 16 to 76.8MHz

4. NDK Spec. No.

NDK Spec. No.	NSC5359A	NSC5359B	NSC5359C	NSC5359D
Frequency range [MHz]	$16 \leq F < 26$	$26 \leq F < 32$	$32 \leq F \leq 40$	$41 \leq F \leq 76.8$

5. Maximum Rating

	Item	Rating	unit
1	Supply Voltage	-0.6 to +4.6	V
2	Stand-by terminal voltage	-0.6 to V_{cc} +0.6, Max.+4.6	V
3	Storage temp. range	-40 to +85	°C

6. Rating

	Item	Rating				Notes
		Min.	Typ.	Max.	Units	
1	Nominal frequency	16		76.8	MHz	Refer to Table1. (-Earth)
2	Supply voltage (V_{cc})	+1.7	+1.8	+3.3	V	
3	Operating temp. range	-30		+85	°C	
4	Load impedance (resistance part)	9	10	11	k Ω	
5	Load impedance (parallel capacitance)	9	10	11	pF	

7. Electrical specification

Unless otherwise specified, measuring condition: $T=+25 \pm 2$ °C, $V_{cc}=+1.8$ V, Stand-by $=+1.8$ V, Load = 10 k Ω // 10 pF

	Parameters	Electrical Spec.				Notes
		Min.	Typ.	Max.	Units	
1	Current consumption	-----		5.0	mA	Operation
		-----		4.0	μ A	Stand-by
2	Output voltage	0.8			V_{p-p}	Clipped sine wave (DC-Coupling)
3	DC-cut capacitor					DC-cut capacitor of output is not put in TCXO. Please add DC-cut capacitor (1000 pF) in output line.
4	Frequency stability					
	1. Frequency /Temperature characteristics	-0.5		+0.5	ppm	-30 to +85 °C Based on frequency at $+25 \pm 2$ °C
	2. Frequency/Voltage coefficient	-0.2		+0.2	ppm	$V_{cc} \pm 5$ % (at $+25 \pm 2$ °C)
	3. Frequency/Load coefficient	-0.2		+0.2	ppm	(10 k Ω //10 pF) ± 10 %,
	4. Frequency tolerance	-2.0		+2.0	ppm	After 2 times reflow soldering, based on nominal frequency
5	5. Long-term frequency stability	-1.0		+1.0	ppm	year (at $+25 \pm 2$ °C)
	Stand-by function					
	1. High input voltage	80 % V_{cc}		V_{cc}	V	Operation
	2. Low input voltage	0 V		20 % V_{cc}	V	Stand-by

Table.1. Main frequency list

※Please contact us for frequencies not listed.

NDK Spec. No.	Current consumption [mA]	Nominal frequency [MHz]					
		16.368	16.369	22.5792	24.576	-	-
NSC5359A	Max.4.0	16.368	16.369	22.5792	24.576	-	-
NSC5359B	Max.4.0	26	-	-	-	-	-
NSC5359C	Max.4.0	32	38.4	40	-	-	-
NSC5359D	Max.5.0	45.1584	48	49.152	50	52	76.8

Output waveform

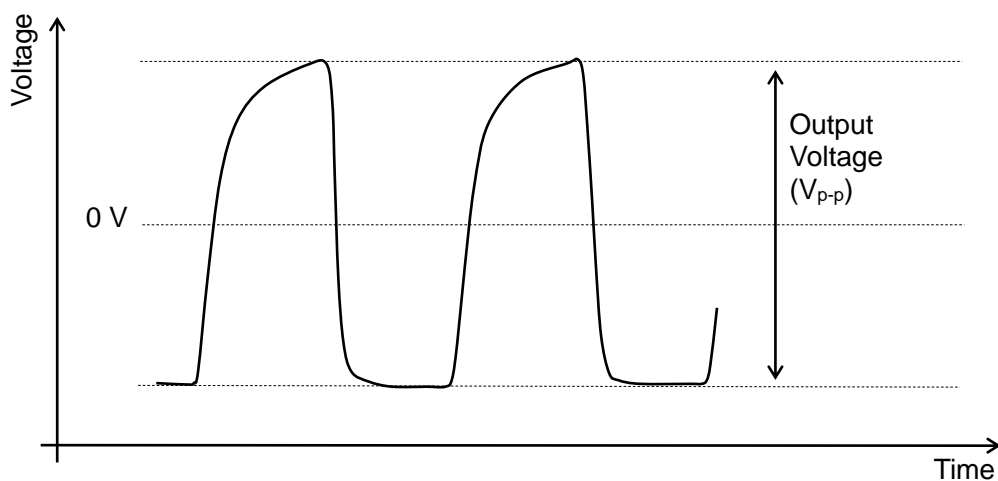

Measurement circuit

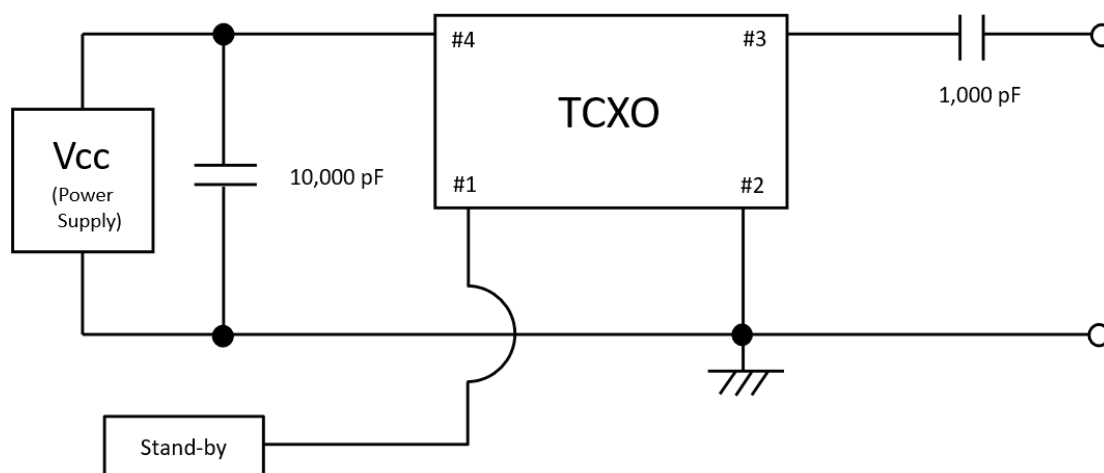

8. Mounted conditions

Reflow solder mounting is recommended.

The temperature profile is as follows.

Soldering peak temp. +260 °C

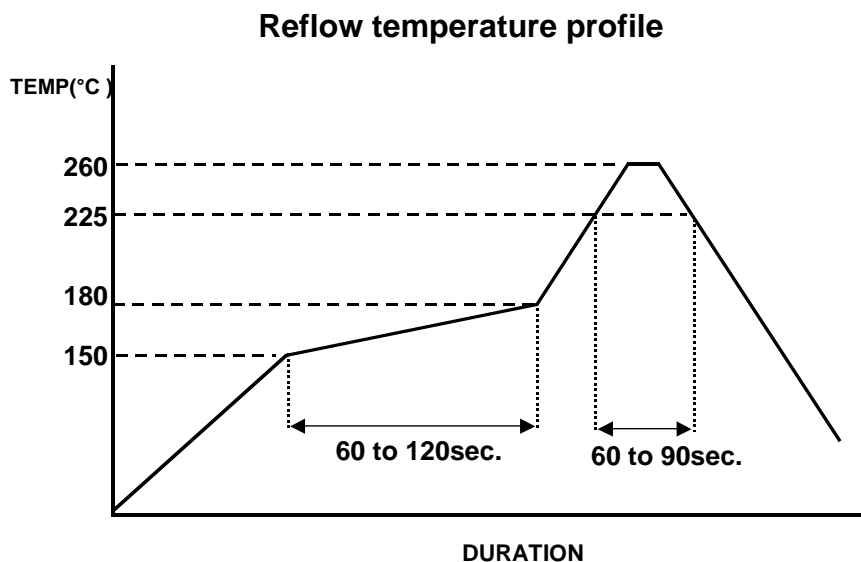

9. Precaution in the storage

When storing the product in high temperature and high humidity condition for a long time, product characteristics (solder ability etc.) and packaging condition may be deteriorated. The product storage deadline is 1 year after delivery in unopened state. Please use within 1 year. If you exceed 1 year please check the product characteristics etc, please use. Please keep the oscillator under below condition.

MSL		After taking out of dry bag
2	Temperature	+30 °C max.
	Humidity	60 % max.
	Period	1 year max.

(table)

10. Electrostatic withstand voltage specification

- Machine Model / MM
Max. ± 200 V (Standards / JEDEC EIA: JESD22-A115)
- Human Body Model / HBM
Max. ± 2000 V (Standards / JEDEC EIA: JESD22-A114)
- Charged Device Model / CDM
Max. ± 500 V (Standards / JEDEC EIA: JESD22-C101)

External dimensions

Units: mm

Tolerance : ± 0.1

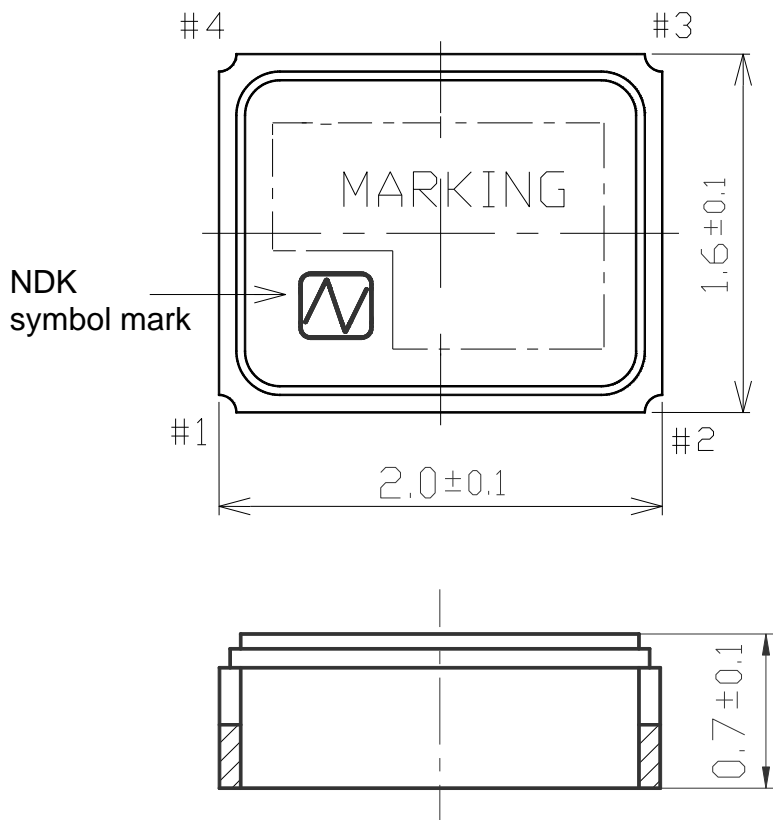

Terminal land connections

#1	Stand-by
#2	GND
#3	OUTPUT
#4	V _{CC}

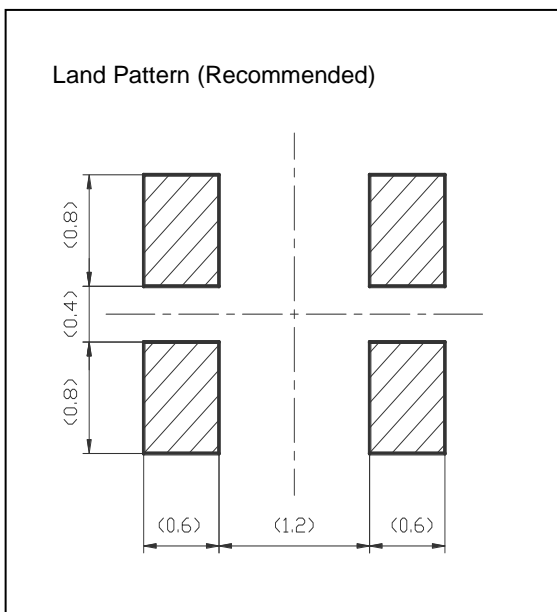
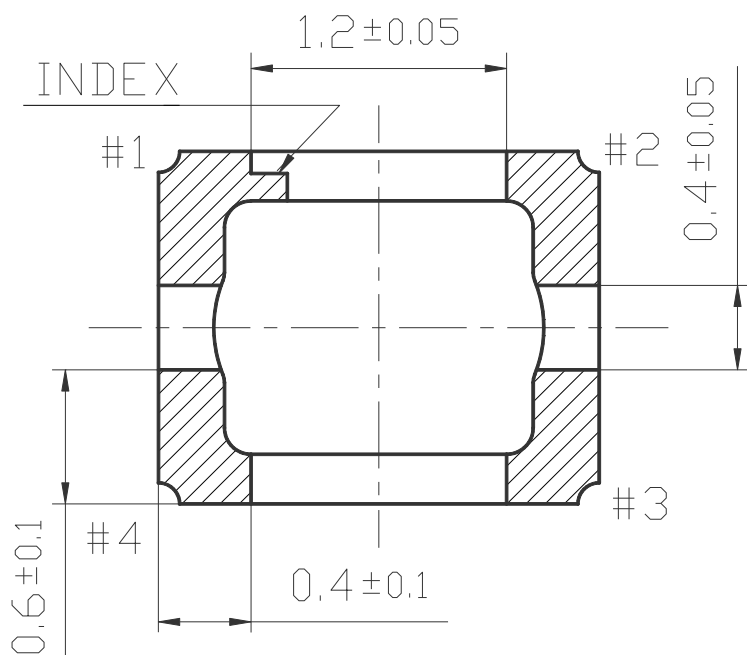

■ Taping & reel specifications

Units: mm

Storage quantity : Max. 3,000 pcs

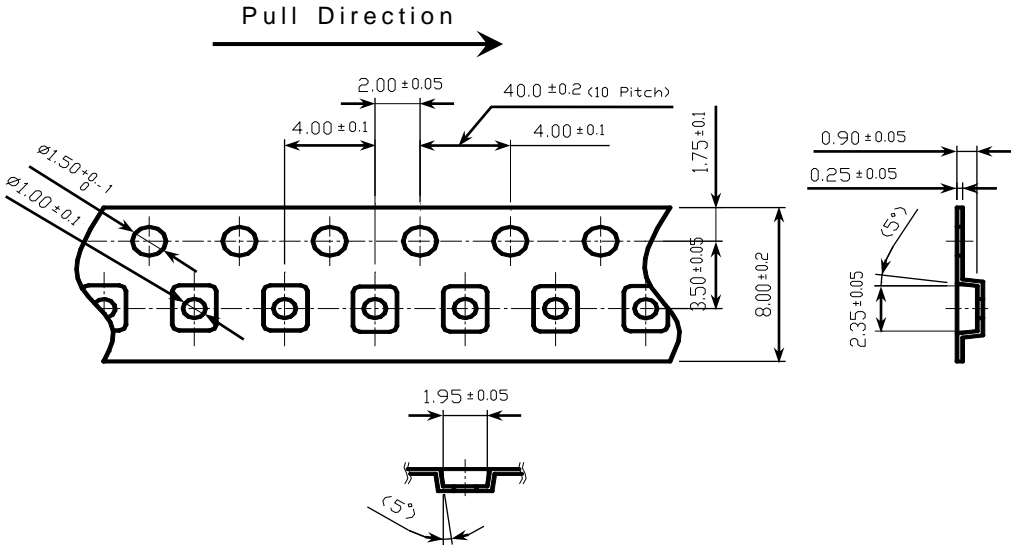

	Embossed carrier tape	Top cover tape
Materials	PS	PET + PE + Adhesive layer
Disposition	Antistatic	Antistatic

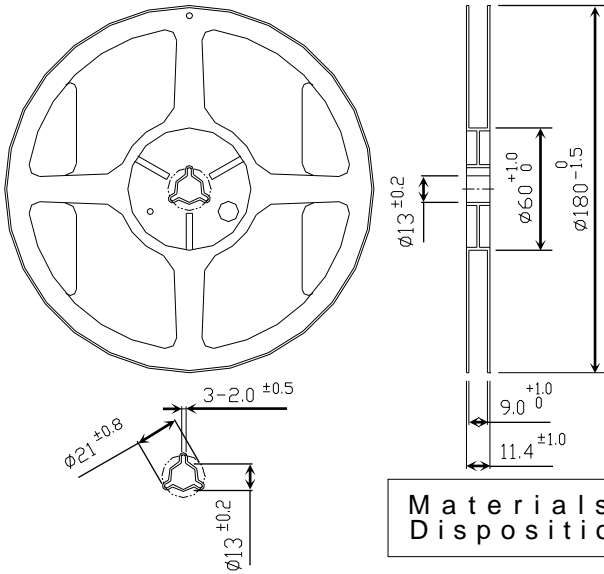

Materials : PS
Disposition: Antistatic

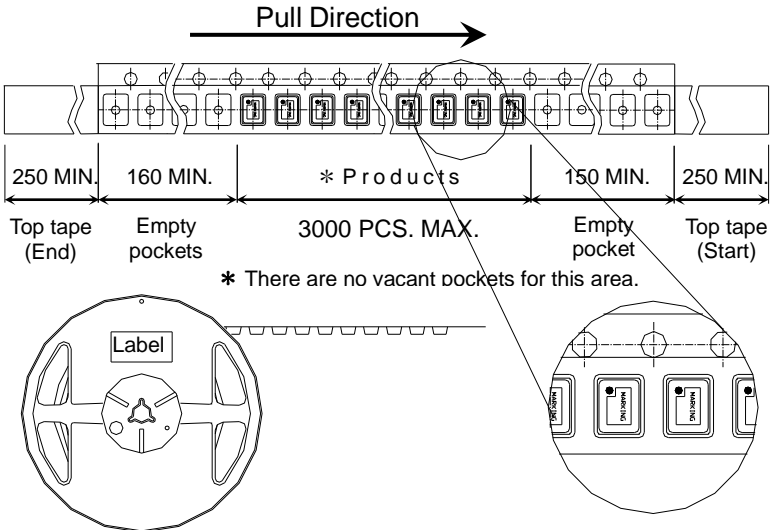

■ Marking specifications

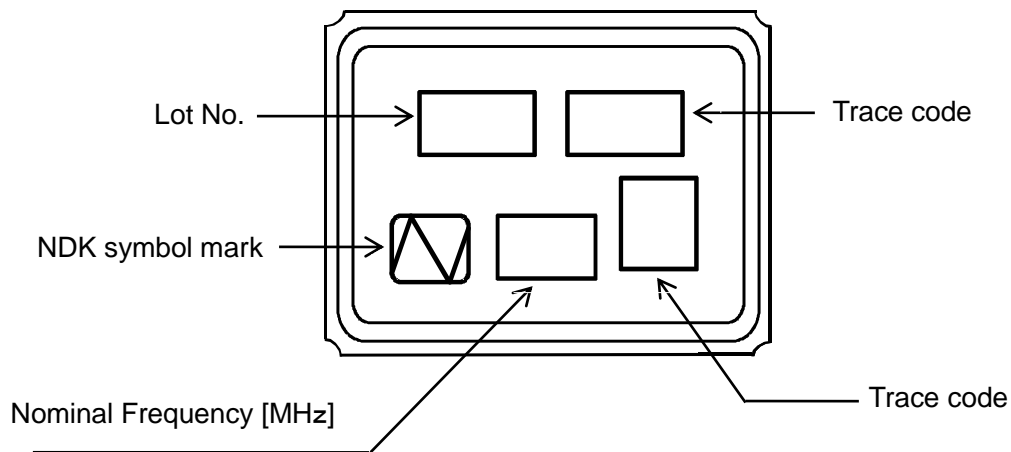

【Reference】

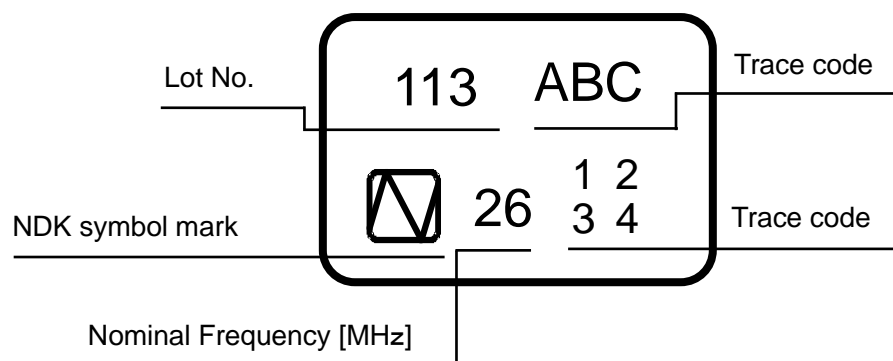

■ Reference data 【Frequency: : 26 MHz】
 Frequency temperature characteristics

Specification : Max.±0.5ppm/-30 to +85 °C

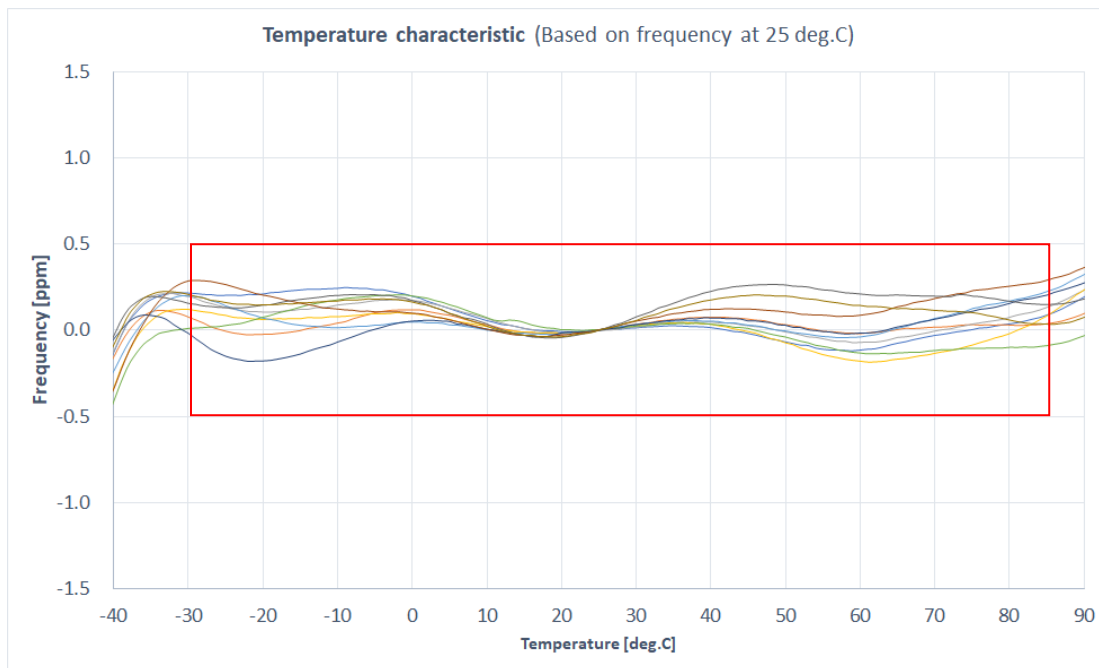

Phase noise

Temp =+25 ±2 °C, V_{CC} = 1.8 V

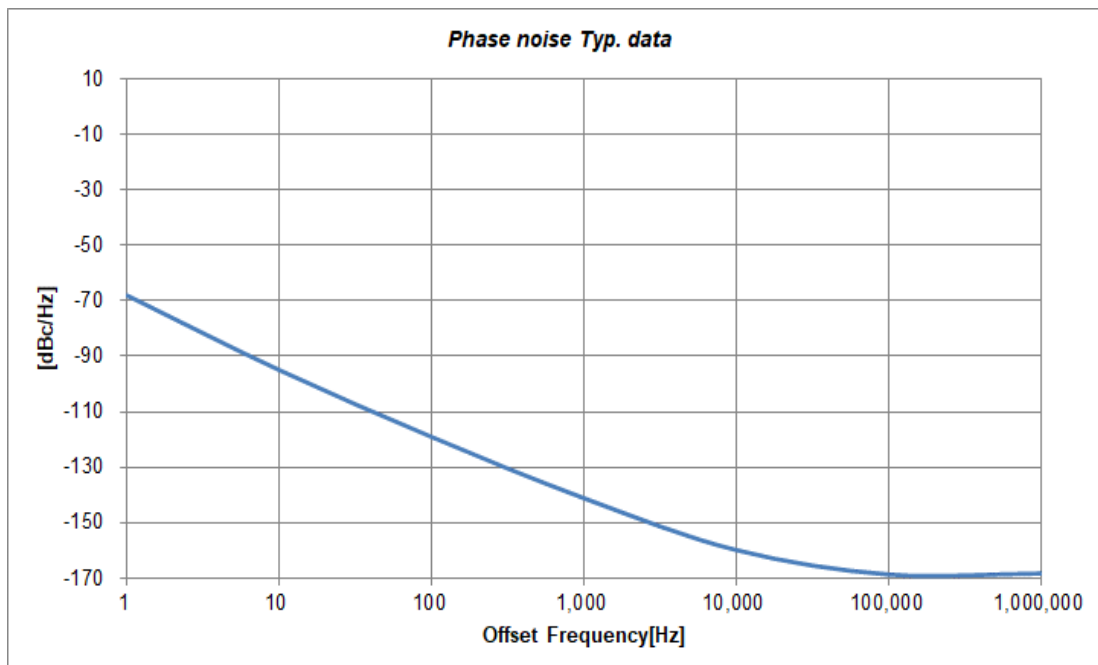

Handling Precautions

1. DC-cut capacitor
DC-cut capacitor of output is not put in TCXO. Please add DC-cut capacitor (1000 pF) in output line.
2. Frequency establishment condition
When output frequency is set, we suppose to have the ground pattern under the oscillator.
3. Washing
Not available for washing.

Notes on use

- 1 This product cannot be used for automotive applications.
We have other products available for automotive applications so please contact us.
- 2 Even if the appearance color etc. of the product differs by purchasing the component parts by more than two companies, there is no influence on the characteristics and reliability.
- 3 IN THE CASE OF THE FOLLOWING ITEMS, WE ARE NOT RESPONSIBLE FOR WARRANTY / COMPENSATION.
 - (1) WHEN PRODUCTS OF THIS SPECIFICATION ARE USED FOR EQUIPMENT RELATED TO HUMAN LIFE OR PROPERTY, IT IS THE RESPONSIBILITY OF THE CUSTOMER TO CONFIRM THE INFLUENCE ON THIS PRODUCT AND EQUIPMENT TO BE USED BEFOREHAND, CONDUCT NECESSARY SAFETY DESIGN (INCLUDING REDUNDANT DESIGN, MALFUNCTION PREVENTION DESIGN, etc.), AND PLEASE USE IT AFTER SECURING SUFFICIENT SAFETY OF EQUIPMENT.
 1. SAFETY-RELATED EQUIPMENT SUCH AS AUTOMOBILES, TRAINS, SHIPS, ETC., OR EQUIPMENT DIRECTLY INVOLVED IN OPERATION
 2. AIRCRAFT EQUIPMENT
 3. SPACE EQUIPMENT
 4. MEDICAL EQUIPMENT
 5. MILITARY EQUIPMENT
 6. DISASTER PREVENTION / CRIME PREVENTION EQUIPMENT
 7. TRAFFIC LIGHT
 8. OTHER EQUIPMENT REQUIRING THE SAME PERFORMANCE AS THE ABOVE-MENTIONED EQUIPMENT
 - (2) IN CASES WHERE IT IS NOT INDICATED IN THE REQUESTED STANDARD AND IS USED UNDER CONDITIONS OF USE (INCLUDING CIRCUIT MARGIN, EFFECT OF HEAT GENERATION OF PARTS USED ETC.) THAT CANNOT BE PREDICTED AT THE PRODUCTION STAGE.
 - (3) WHEN USING ULTRASONIC WELDING MACHINE. (THERE IS A POSSIBILITY THAT THE CHARACTERISTIC DEGRADATION IS CAUSED BY THE RESONANCE PHENOMENON OF THE PIEZOELECTRIC MATERIAL.
(EXAMPLE; CRYSTAL PIECE))
WE WILL NOT TAKE ANY RESPONSIBILITY FOR THE INFLUENCE OF THE CUSTOMERS' PROCESS.
SO, PLEASE SUFFICIENTLY EVALUATE AT A SAMPLE STEP WHEN YOU USE ULTRASONIC WELDING MACHINE.
 - (4) USING RESIN MOLD MAY AFFECT THE PRODUCT CHARACTERISTIC.
PLEASE MAKE SURE TO TELL OUR SALES CONTACT WHEN YOU USE RESIN MOLD.
WE WILL PERFORM INDIVIDUAL CORRESPONDENCE ABOUT A DELIVERY SPECIFICATION AND A EVALUATION METHOD.
IN ADDITION, IF YOU USE RESIN MOLD WITHOUT CONTACTING US, AND CAUSES DAMAGES AGAINST A CUSTOMER OR A THIRD PARTY, WE WILL NOT BE LIABLE FOR THE DAMAGES AND OTHER RESPONSIBILITIES BECAUSE WE CONSIDER IT IS UNDER SELF-RESPONSIBILITY USING RESIN MOLD.
WE WILL NOT TAKE ANY RESPONSIBILITY FOR THE INFLUENCE OF THE CUSTOMERS' PROCESS.
PLEASE EFFICIENTLY EVALUATE AT A SAMPLE STEP WHEN YOU USE RESIN MOLD.

- (5) OPERATION IN HIGH HUMIDITY OR CONDENSATION CONDITIONS WILL AFFECT THE CHARACTERISTICS. IF SUCH ENVIRONMENT USE, PLEASE TAKE MEASURES AGAINST WATERPROOF.
- (6) When using this product, please insert a bypass capacitor between the power supply and GND. (Closer to the product terminal is desirable.)
The bypass capacitor values shown in our specifications and drawings are for reference only. (They are not guaranteed values.)
In actual use, please select the appropriate bypass capacitor value for your circuit.
NDK shall not be liable for any and all events resulting from or in connection with the use of this product in a manner that does not comply with the above instruction.
- (7) WHEN PERFORMING IMPROPER HANDLING THAT EXCEEDS THE GUARANTEED RANGE.

Prohibited items

Be sure to use the product under the following conditions. Otherwise, the characteristics deterioration or destruction of the product may result.

- (1) Reflow soldering heat resistance
Peak temperature: +265 °C
Heating: +225 °C or higher, 90 sec
- (2) Manual soldering heat resistance
Pressing a soldering iron of +350 ±5 °C on the terminal electrode for 3 ±1 seconds.
- (3) Hot air heat resistance
Blow hot air of +350 ±5 °C on the product for 3 ±1 seconds.

Handling of this document and other requests

Please refer to the " Site Guidance" on our website for the handling of information contained in this document. (<https://www.ndk.com/en/terms/>)